

# 953B INSTALLATION INSTRUCTIONS



Evaporator location

Restrict outside air intake to increase A/C performance



3/8" weld nuts used to clamp coil in place

Mount thermostat in existing location. Use knife to cut out decal. Connect yellow wire (521) on blower switch to thermostat.

Seal any space with tar tape

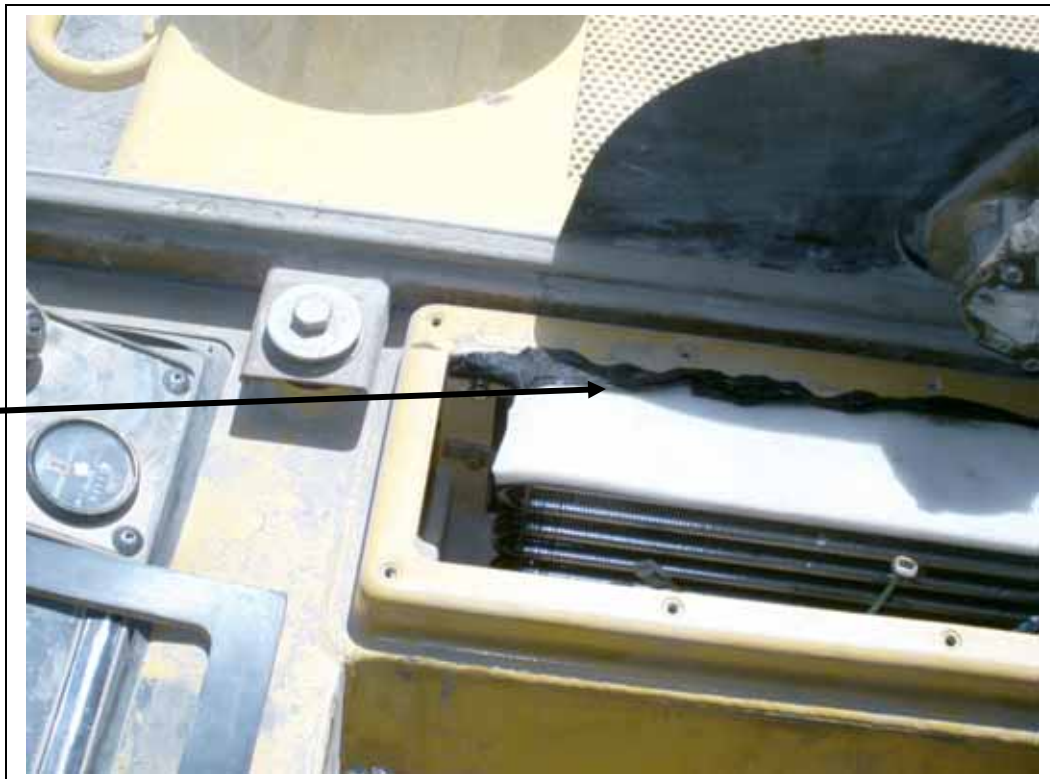

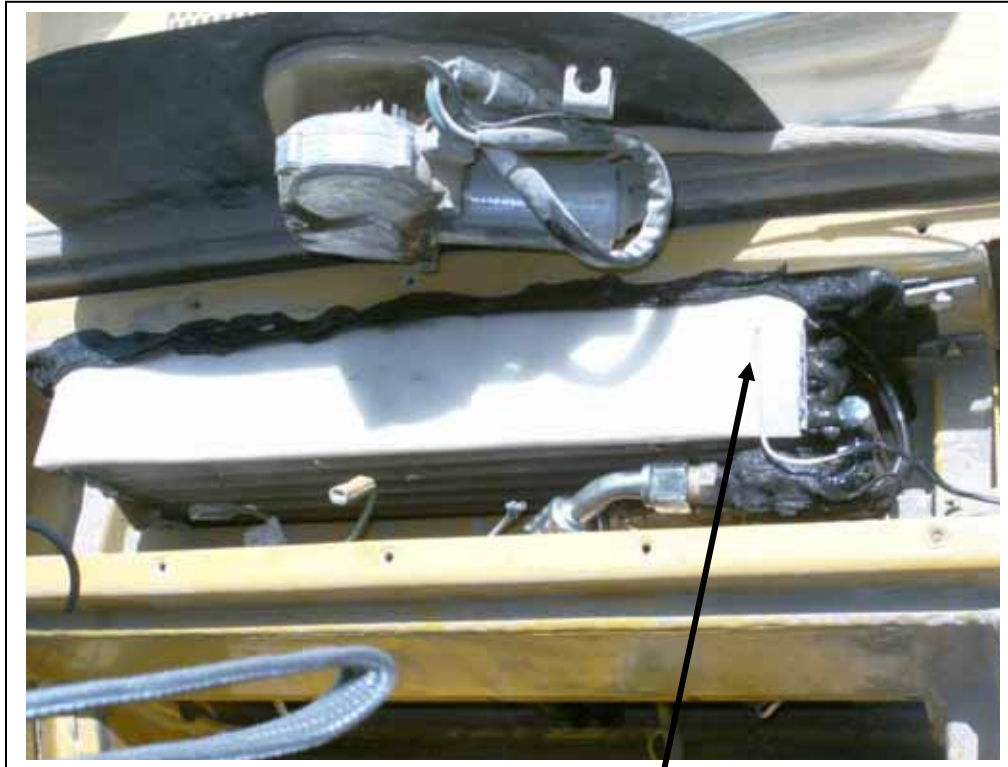

Thermostat probe location under foam



Drill, cut, chisel open this area to allow A/C hoses into the cab.





A/C hoses and wiring coming up through the floor of the cab.



Seal opening with tar tape once the hoses are run into the cab



Receiver drier location

Hoses to run up here as far as possible to allow cab to tilt



Receiver drier mount location



Compressor and mount in place







Hose routing to opening in bottom of cab. Run so that the cab can be tilted up.



Compressor

Pulley groove used for compressor drive



Left side of condenser mounted to fan screen

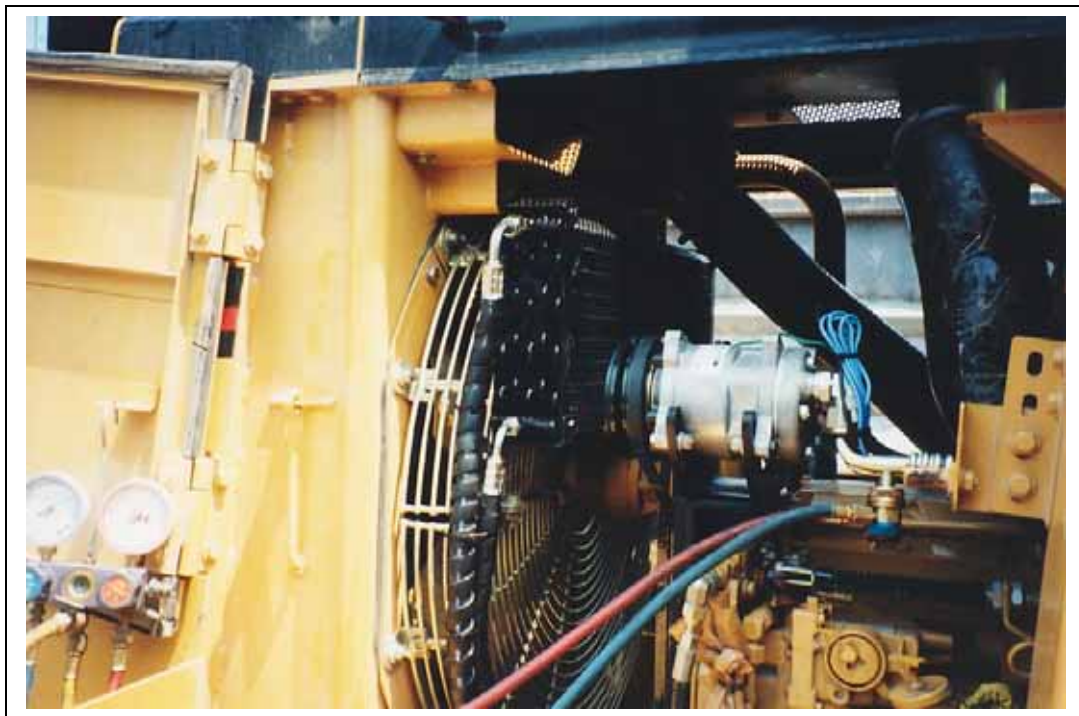

Right side of condenser mounted to fan screen



## **CHARGING AND TESTING**

- 1) Pressure test the system using nitrogen to a pressure of 250 psi. Check for leaks.
- 2) Add 2oz of SP15 Sanden PAG oil to the system.
- 3) Vacuum the system for at least ½ hour.
- 4) Check that the vacuum holds.
- 5) Fill the system with to 3 lbs of R134a refrigerant. **DO NOT USE ANY OTHER TYPE OF REFRIGERANT OR IT WILL VOID THE WARRANTY.**
- 6) Test the system. Check the cycling temperature of the thermostat. Adjust the thermostat settings if required to avoid coil freeze up problems. See the thermostat setting procedures at the end of these instructions.

## Aeroquip E-Z Clip Assembly Instructions

Step 1. Cut the hose to proper length with an appropriate cutting tool. Aeroquip's hand held hose cutter has been specially designed for cutting all non-wire reinforced hose, such as GH-134 Multi-Refrigerant hose. Be sure the cut is made square to the hose length.

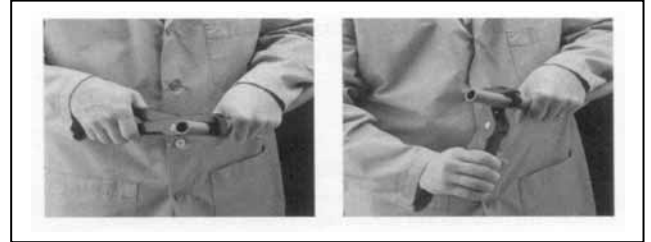

Step 2. Install two proper-sized clips onto the cut end of the hose. Orientation of the clips does not affect the performance of the connection. However, for ease of assembly, both clips should have the same orientation. NOTE: Failure to slide the clips over the hose at this time will require the clips to be stretched over the hose or fitting later. This may permanently damage the clip.



Step 3. Lubricate the nipple with a generous amount of the refrigeration or A/C system's compressor lubricating oil. This MUST be done to lower the force of nipple insertion.

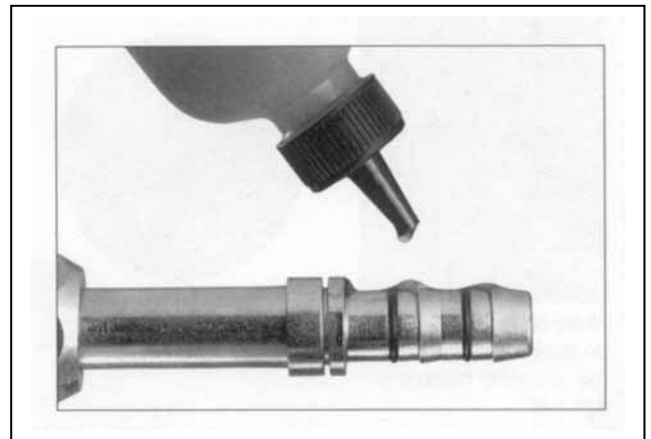

Step 4. Insert the nipple into the hose. To ensure that the nipple is fully inserted, check the gap between the cut end of the hose and the shoulder on the nipple. Care should be taken to avoid kinking or other damage to the hose during nipple insertion. NOTE: Be sure to wipe excess oil from the nipple and hose.



Step 5. Snap the cage into the groove on the nipple. The arms should extend over the hose length. When the cage has been correctly installed in the cage groove, the cage will be able to rotate in the groove. This step **MUST** be performed to ensure:

1. The clips will be located over the O-rings on the nipple.
2. The connection will be compatible with the connection's pressure rating.

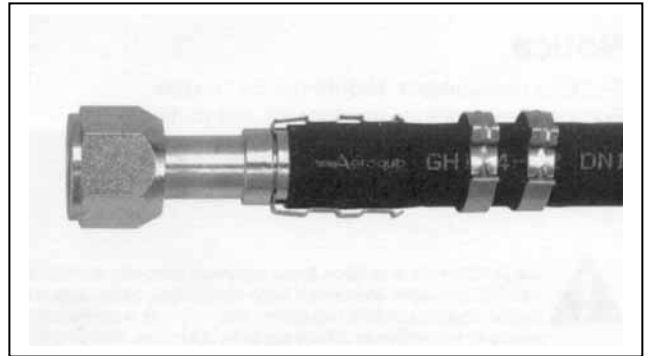

Step 6. Slide the clips over the cage arms and into the channels on each arm.

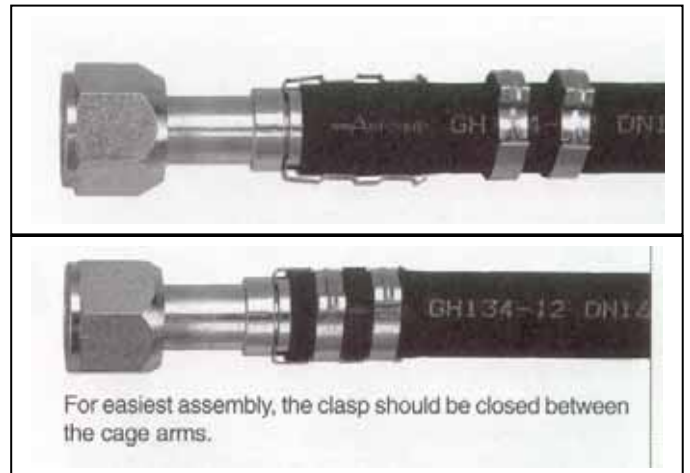

Step 7. Use the pliers to close the clips. The pliers should be positioned squarely on the clip connection points and should remain square during the closing of the clip.

**NOTICE:** E-Z Clip components should not be reused.

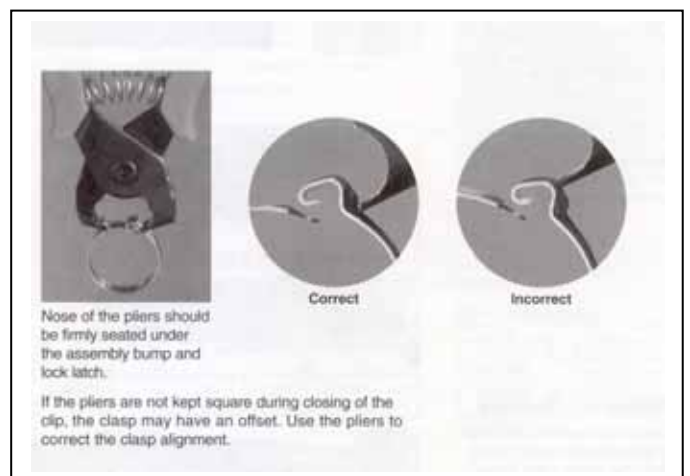



SLIP THE SPINLOCK  
BETWEEN THE FAN  
SCREEN BARS

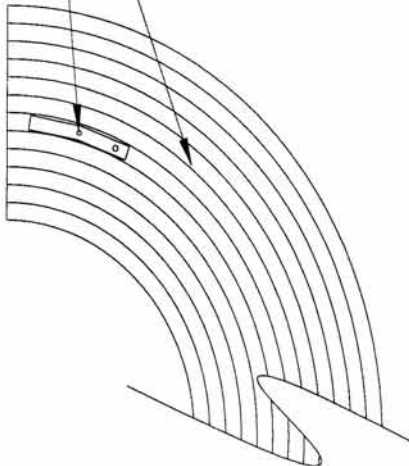

AND ROTATE 90 DEG.  
AND TIGHTEN DOWN  
CONDENSER  
FENDER WASHERS

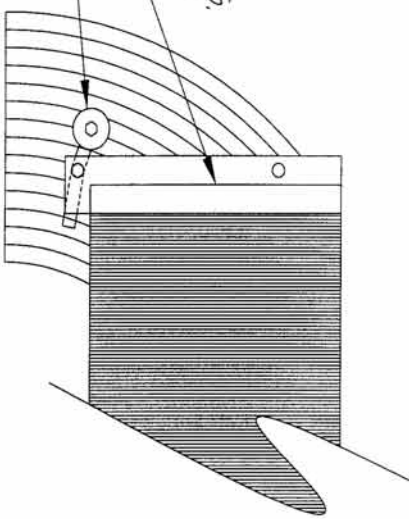

DRAWING TITLE:	SPINLOCK INFO.
DRAWN BY:	J.S.
APPROVED BY:	J.L.
MODIFIED ON:	MAR. 15, 2002
REV.:	0
UNITS:	S.A.E.

# Refrigerant Flow Pattern in a Standard Air Conditioning System

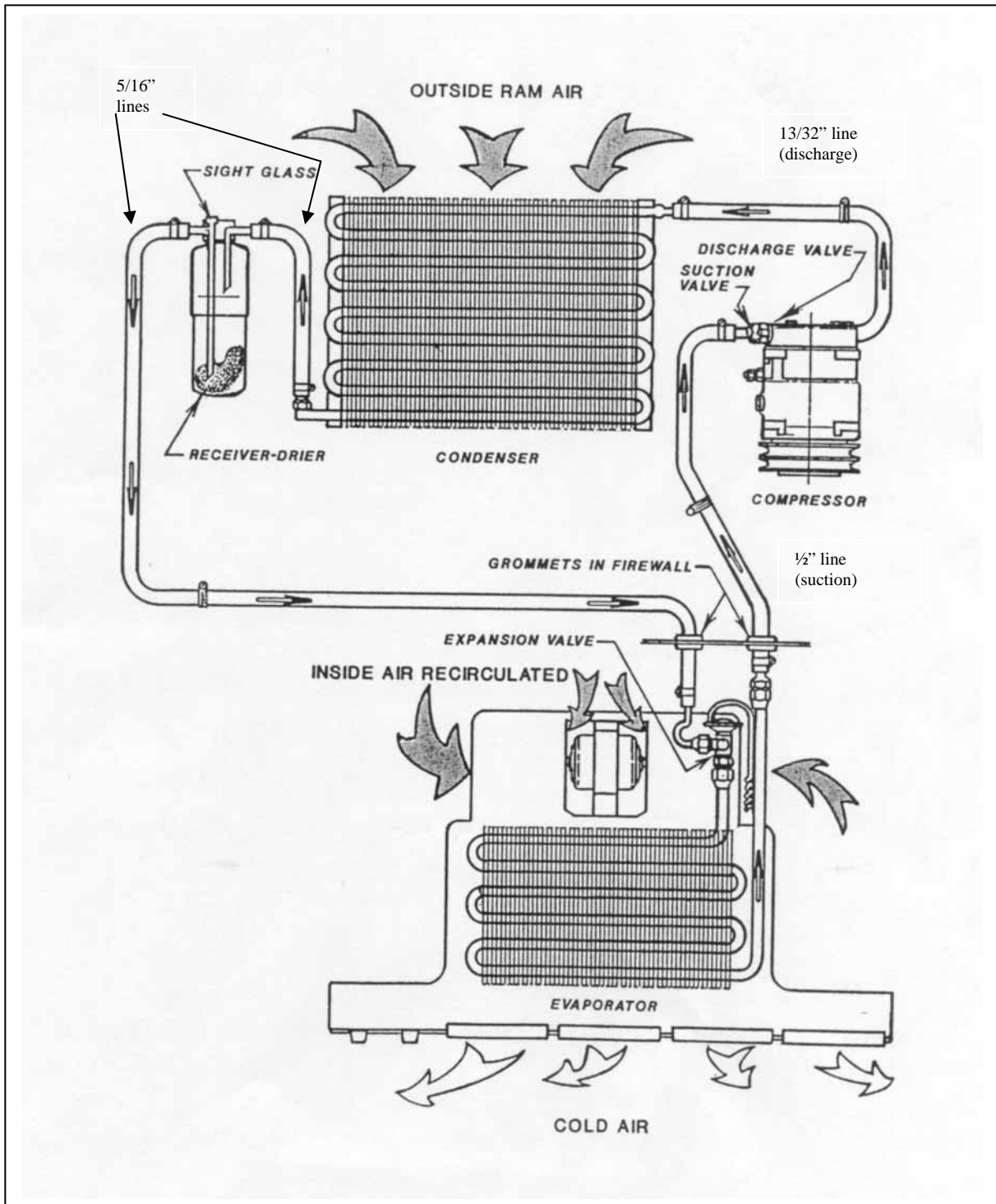

## Thermostat Setting Procedures

- 1) Thermostat types
  - a) preset
  - b) adjustable
    - a) A preset thermostat is adjusted to its specific cut in and cut out temperatures when manufactured and does not have a rotary adjustment for the operator.
    - b) An adjustable or rotary thermostat has been manufactured to a predetermined cut in and cut out temperatures, but it is also operator adjustable to achieve the desired comfort level.

Both types of thermostats can have their factory settings adjusted by turning the setting screws on the body of the thermostat. One body type has the setting screws mounted externally and labeled for direction of rotation. The other body type requires the removal of the plastic end plate to expose the set screw.

- 2) Thermostat probe location: The location of the thermostat probe in an evaporator coil can be very important to achieve the maximum cooling potential of the coil while also preventing coil freeze-up. There is no set location for the thermostat probe to be put that will be optimum for all systems, but several rules of thumb may be followed:
  - a) Insert the probe in the coldest area of the evaporator coil.
  - b) Insert the probe from the top of the coil down, if possible.
  - c) Make sure that at least the last 3" of the thermostat probe are in the coil.

To find the most likely area where the coil is the coldest, consider these factors:

- 1) Direction of air flow through the coil.
  - 2) The coil area likely to have the lowest air flow.
  - 3) The inlet locations of the refrigerant into the coil.
  - 4) The inlet of the hotter outside air into the coil area.
- 
- 1) Usually the coldest side of the evaporator coil will be the air outlet side. Often the thermostat probe can be inserted between the last and second last row of tubes.
  - 2) The lower air flow area of the evaporator coil in most systems tends to be near either end of the coil. These areas will be colder
  - 3) The area of the coil that the refrigerant inlet tube(s) occupy should be the coldest part of the coil.
  - 4) If the system is equipped with an outside air intake, where and how that air is brought into the evaporator area can have a large effect on the coil temperature. If all the outside air is piped into the evaporator in one area, that area will be considerably warmer in hot weather.

By looking at all these different factors, the area of an evaporator coil most likely to be the coldest can be determined.



Once the probe is inserted, the A/C system needs to be tested. Run the system to ensure that the thermostat is cycling the compressor off at the appropriate temperature. A core temperature ranging between 25° and 30° F should cause the thermostat to cycle off. The air temperature at the vent outlet closest to the evaporator coil should be between 38° F and 45° F when the compressor cycles off.

If the thermostat doesn't cycle off after a reasonable cool down period, and the air outlet temperature has dropped below 40° F, the cut in and cut out settings should be adjusted until the compressor is cycling on and off regularly. Let the system run for a decent time period (at least 15 min) and then check the evaporator coil for any signs of freezing.